

中空軸旋轉平台 Hollow Rotary Actuators

型號識別 Model number code

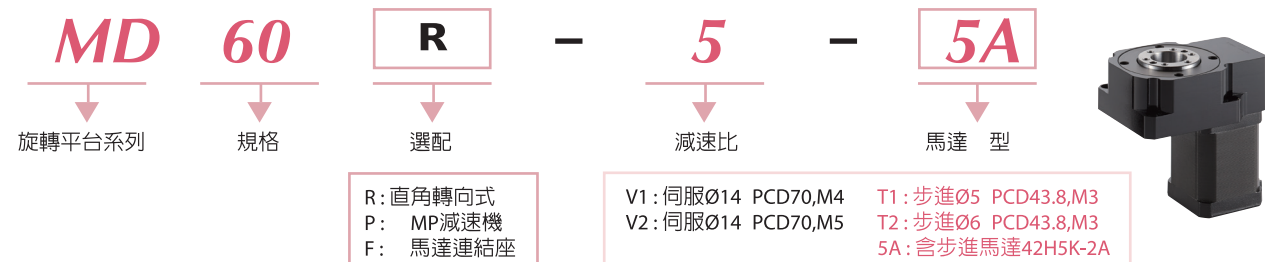

MD60-5-5A (此型號含步進42H5K-2A)

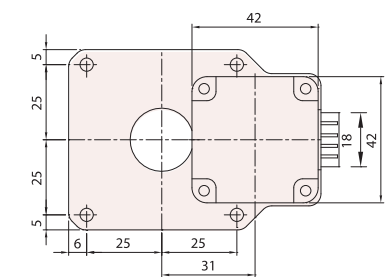
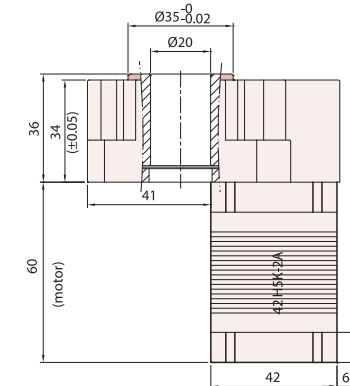
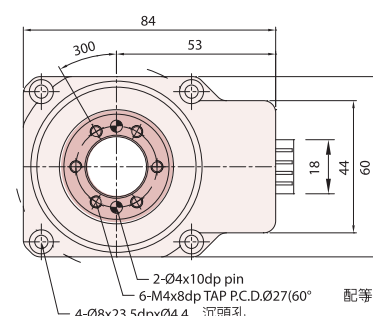

A+	黑
A-	綠
B+	紅
B-	藍

MD60F-5 (附連結座可自行組裝馬達)

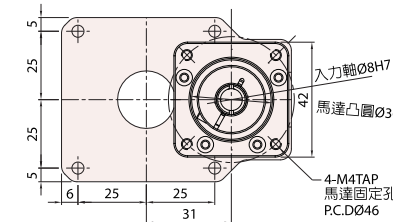
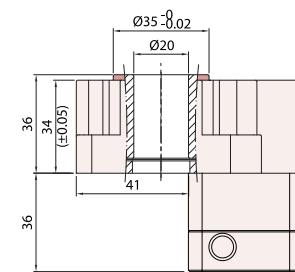
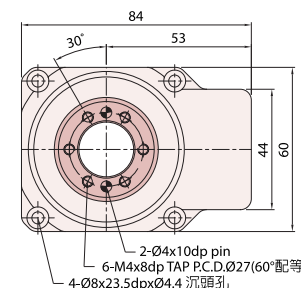

產品型號	MD60	MD60R
旋轉平台軸承	深溝滾珠+止推滾珠軸承	
容許轉矩N.m	5	
精度壽命	15000 Hrs	
允許轉速rpm	200 (盤面)	
減速比	5	15
重覆精度arc-sec	≤ 15	≤ 20
定位精度arc-min	≤ 1	≤ 1
旋轉平台平行度mm	≤ 0.02	
旋轉平台同心度mm	≤ 0.02	
保護等級	IP40	

P.S:圖周單位: 1 rpm = 360° 1°=60'(arc-min) 1'=60"(arc-sec)
圖周誤差換算直線誤差: 盤面直徑x 3.14159 ÷ (360°x60'x60") x背隙值

定位精度檢測 此規格定位精度僅以比例檢驗

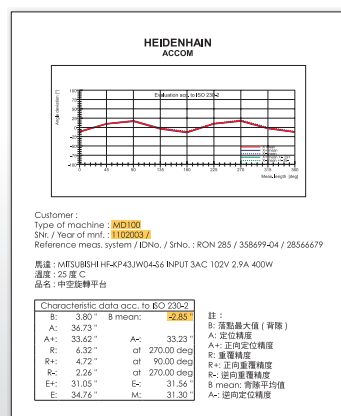

盤面同心度檢測 ≤0.02mm

盤面旋轉振幅 ≤0.02mm

盤面與底座平行度 ≤0.02mm

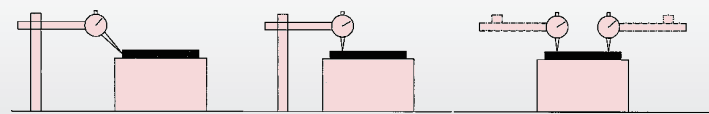

外徑任意點定位精度
半徑 17.5mm
≤ 1min

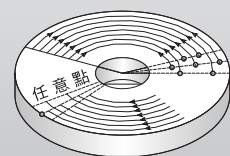

反覆定位精度
半徑 17.5mm
≤ 15 sec

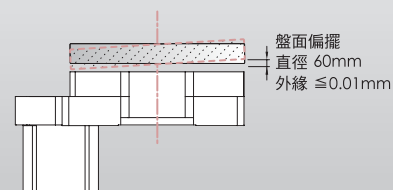

MD60R-15 (直角轉向式 1:15)

